

Greenwich Dining Chairs

601 Side Chair

602 Arm Chair



SEASIDE CASUAL

MADE IN RHODE ISLAND



ASSEMBLY INSTRUCTIONS

1

PLEASE READ INSTRUCTIONS COMPLETELY BEFORE BEGINNING.
Carefully remove contents from box. Make sure that all parts and hardware are included using the Parts List below.

Tools Required: 4mm Allen Wrench (included); #2 Phillips Head Screwdriver;
(Recommended: Rubber Mallet; High Powered Drill)

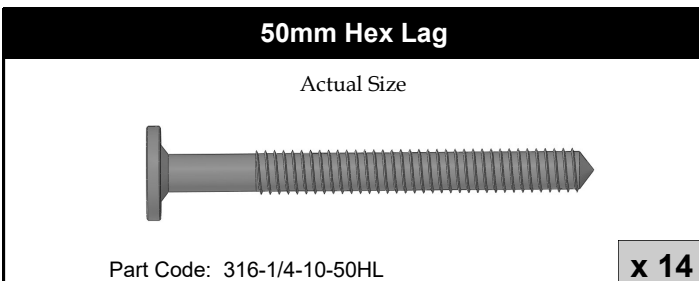
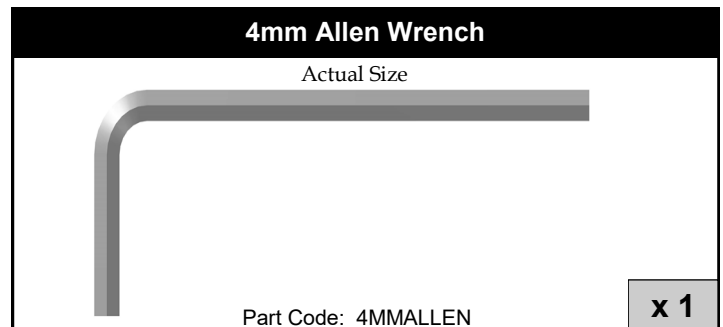
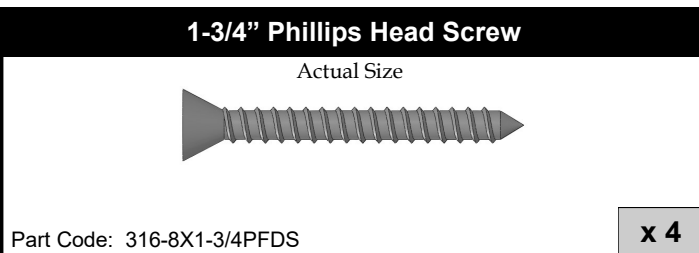
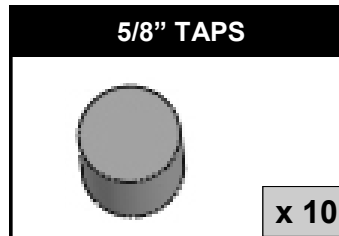
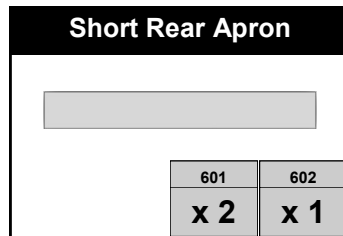
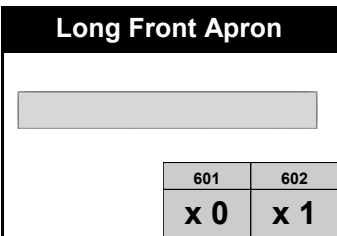
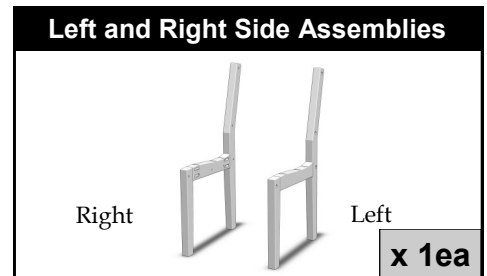
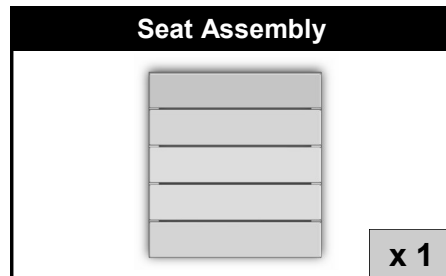
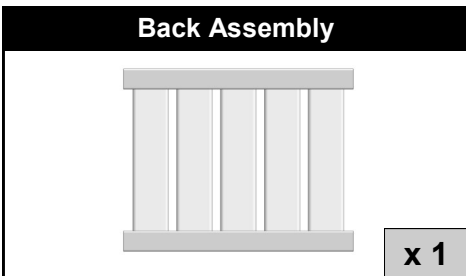

WARRANTY QUESTIONS OR COMMENTS PLEASE CALL TOLL FREE AT 1-800-809-3114
Seaside Casual Furniture | 11 Industrial Drive Coventry, RI 02816 | 800-809-3114 | sales@seasidecasual.com

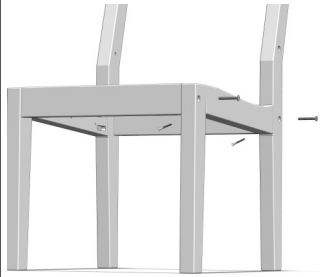
2**ATTACH APRONS TO SIDE ASSEMBLIES**

Align Front and Rear Aprons with Front and Rear Legs. Secure with (4) 50mm Hex Lags through counter-bored holes in legs, and (4) 1-3/4" Screws through pockets in Aprons. Plug holes in legs with 5/8" TAPS.

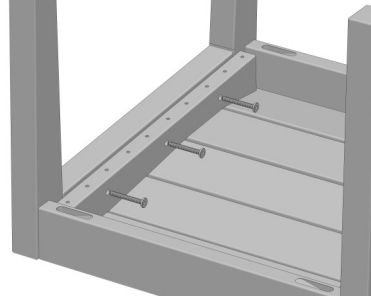
3**ATTACH SEAT ASSEMBLY TO SIDES**

Secure Seat Assembly to Side Assembly using (6) 50mm LAGS.

4**ATTACH SEAT ASSEMBLY TO SIDES**

Secure Back Assembly to Side Assembly using (4) 50mm Lags. Note: Tag location describing "FRONT"